

# HiB

MAKING  
**BATHROOMS**  
BEAUTIFUL

## LIBRA

Art No 21400

## ECLIPSE

Eclipse Round Art No 21100 / Eclipse Square Art No 21200

### Libra

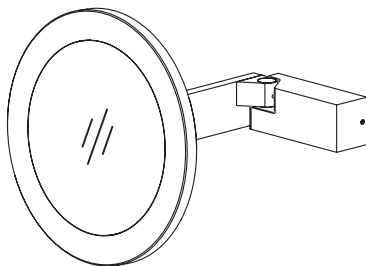

### Eclipse Round

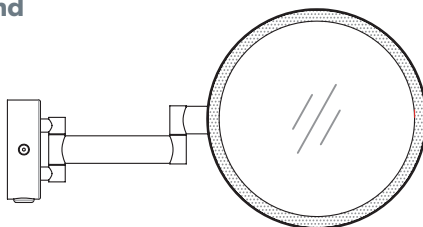

### Eclipse Square

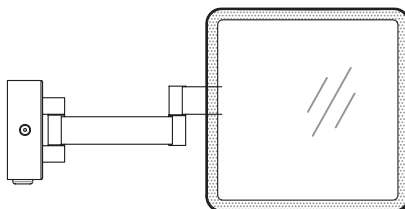

Fitting Instructions

**Thank you for purchasing this HiB product.**

Please read through these instructions carefully and refer back to them during installation to ensure that your product is fitted safely and that it retains its high quality finish.

## Electrical Safety Information

HiB recommends that all electrical bathroom products must be installed in accordance with current building and wiring regulations.

**If in doubt please contact an electrician.**

**Before drilling ensure that there are no hidden cables or pipes in the wall.**

## Warnings for Safe Use

- This product is intended for Domestic Use only.
- Please read the instructions and warnings carefully before installing the product and ensure this document is kept with the product for future reference to ensure product longevity and in the interest of safety.
- If you give the product to another person, please give them this manual as well.
- If any modification is made it will invalidate the warranty and may render the product unsafe.
- This product is IP44 rated and suitable for installation in Zones 2 and Outside Zones according to the IEE regulations.
- It is not suitable for use in saunas, steam rooms and shower cubicles.
- Appropriate circuit protection should be available for the product.
- When drilling use appropriate eye protection.
- The use of a Residual Current Device (RCD) is advised for any power tools used during the installation of this product.
- Take suitable precautions when handling glass.
- Beware of hidden cables or pipes. Take care if drilling on tiled surfaces in case the drill slips.
- Always switch off the electrical supply to the product at the mains during installation and maintenance.
- It is recommended that this product is installed by a person who is able to meet the level of competence required in order to comply with relevant regulations. If in doubt consult a qualified tradesperson.
- Do not enter IP44 box unless competent and item is isolated from mains.
- Do not use if glass is broken or unsafe.
- Do not use if any electrical wires appear damaged or degraded.
- Do not overload shelves or unit.
- This product is designed for installation into a brick or masonry block wall, if mounting onto other substrate ensure appropriate fixing and batons (if required) are used and the load bearing of the wall is sufficient.
- It is recommended that this product is installed by two people.
- Dispose of packaging in accordance to local authority regulations.
- At end of life dispose of item according to local authority regulations.

# Electrical Information



Fig 1. - Zonal Diagram

All installations must comply with guidelines which are based on a zonal concept and must be followed to ensure the safe installation of electrical appliances in the bathroom.

These regulations apply to domestic installations only. Installations must be made in accordance with the current IEE wiring regulations and relevant building regulations.

This product is IP44 rated and is suitable for installation in zones: **2 & Outside Zone**

## Wiring Diagram

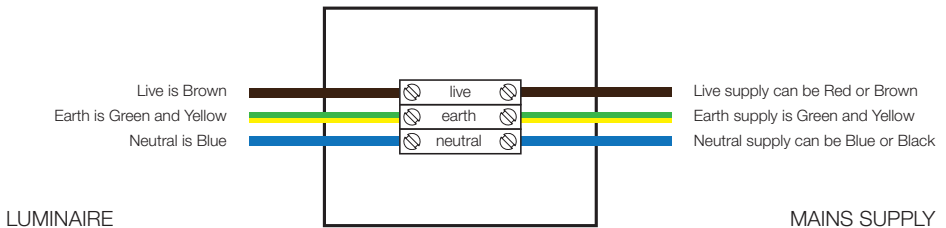

## What's in the Box?

- Mag Mirror
- Wall bracket
- Fittings pack

## Tools Required



Pencil

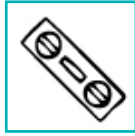

Spirit Level



Drill



Drill bit



Screwdriver

## Figures

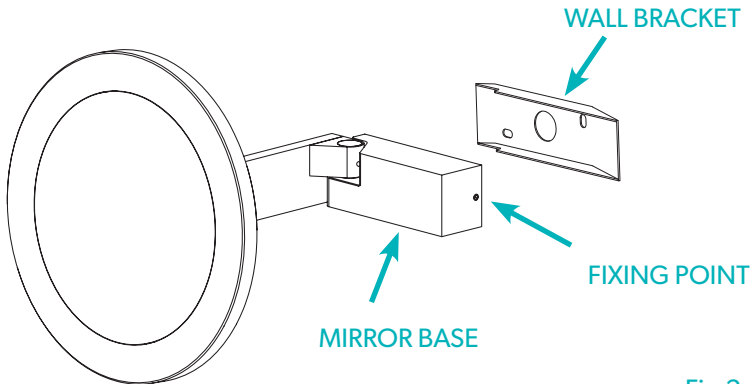

Fig 2. - Libra

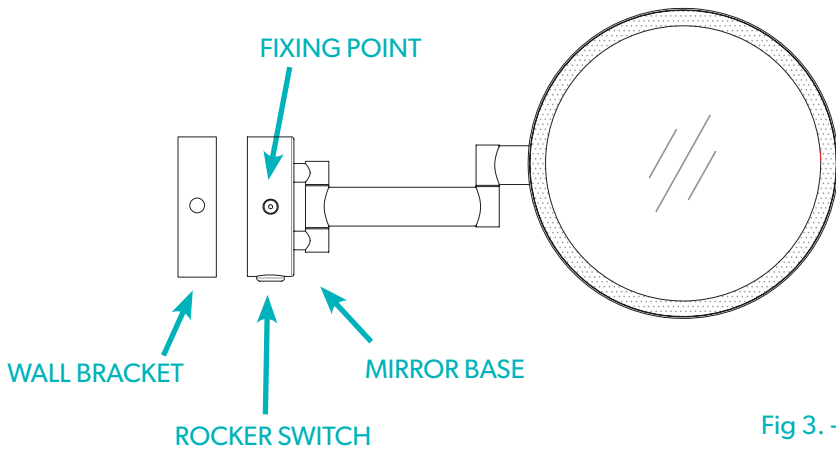

Fig 3. - Eclipse

1. Position the magnifying mirror in a suitable location according to the zonal diagram, *see Fig.1*, ensuring that the domestic electrical mains supply is within reach of the electrical entry point of the product. **Do not position in direct sunlight as the magnifying effect of the mirror may pose a fire hazard.**
2. Remove the wall bracket from the base of the mirror via the fixing(s) on the base of the unit *see Fig 2&3*.
3. Using the wall bracket as a guide, carefully mark the required drilling locations using a soft pencil, ensuring it is level. Remove the wall bracket. **Please ensure all marked drill positions accurately match up with the fixing points of the wall bracket before drilling.**
4. Using a suitable drill bit, drill holes in the marked positions to a suitable depth. If drilling through tile, use a ceramic drill bit.
5. Insert wall plugs level with the surface of the wall. If fitting to a tiled surface, wall plugs should be inserted below the tile surface to avoid cracking. **NB. For plasterboard walls, specialist fixings should be purchased, available from any DIY or hardware store.**
6. Fix wall bracket into wall plugs.
7. Connect the domestic mains supply to the terminal box according to the wiring diagram.
8. Place the mirror onto the wall bracket and secure into place using the fixing(s) on the mirror base – take care not to trap wiring when assembling the mirror onto the wall bracket.
9. Switch on the domestic electrical mains supply to the mirror.



BLANK PAGE

### **LIBRA**

#### **Turn On Illumination**

Pull the mirror away from the wall.

#### **Turn Off Illumination**

Push the mirror back towards the wall.

### **ECLIPSE**

#### **Turn On/Off Illumination**

Illumination is switched on and off by the rocker switch on the underside of the mirror base.

## Care

To preserve the high quality finish of your HiB product, please ensure you regard the following care and cleaning recommendations:

- Avoid leaving excessive standing and surface water on the product for prolonged periods of time.
- Clean the product with water and a soft cloth, a mild detergent may be used if required. Ensure any excess moisture is removed after use.
- **Do not use** abrasive sponges or cleaning agents.

## Aftercare

In the unlikely event that this product should fail please contact the retailer from which the item was purchased.



WEEE compliance

Must not be mixed with  
general household waste

T: +44 (0)20 8441 0352 F: +44 (0)20 8441 0219 E: [sales@hib.co.uk](mailto:sales@hib.co.uk) [hib.co.uk](http://hib.co.uk)

Building 3, North London Business Park, Oakleigh Road South, New Southgate, London. N11 1GN

©HiB Copyright: No part of this document may be reprinted or duplicated without HiB consent. All sizes and measurements are approximate, but we do try and make sure they are as accurate as possible. In the interest of continuous product development, HiB reserves the right to alter specifications as necessary. E & OE.